



**Joint Tech**  
Electronic Industrial Co., Ltd.

会社案内

# 内容目次

## 01 会社概要

---

経営理念  
東莞工場  
会社沿革  
会社概要

## 02 製品開発

---

開発能力  
材料の選択  
開発工程  
製品応用

## 03 製造能力

---

加工センター  
スタンピング  
射出成形  
品質管理  
組立の生産ライン

## 04 品質保証

---

物理実験室  
グローワイヤーテスト  
X射線蛍光分光計

## 05 実績情報

---

得意先  
年間売上高  
営業拠点一覧



# 公司使命



燦達電子工業股份有限公司

JOINT TECH ELECTRONIC IND. CO., LTD.



多様な製品で世界に影響を与え、開発技術を向上  
させ、製造工程を強化し続ける専門的なコネク  
ター製造会社です。

良い品質と優れた技術をご提供致します。

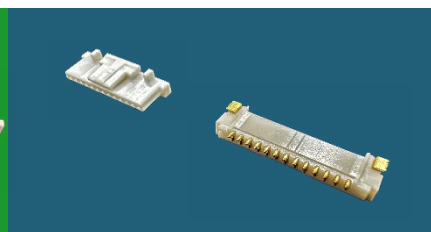
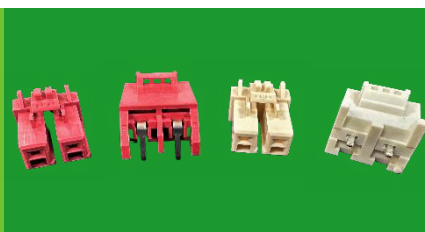
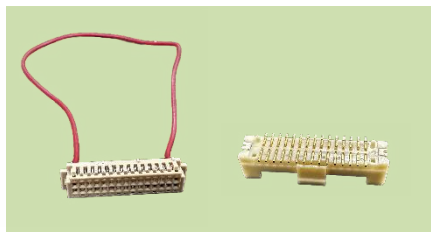

## 東莞工廠



**Joint Tech**

Join your life, design, future

竣工日：2006年

建物面積：24,500 m<sup>2</sup>

敷地面積：4,770 m<sup>2</sup>

社員數：350名

所在地：中國廣東 (東莞市)



# 公司沿革

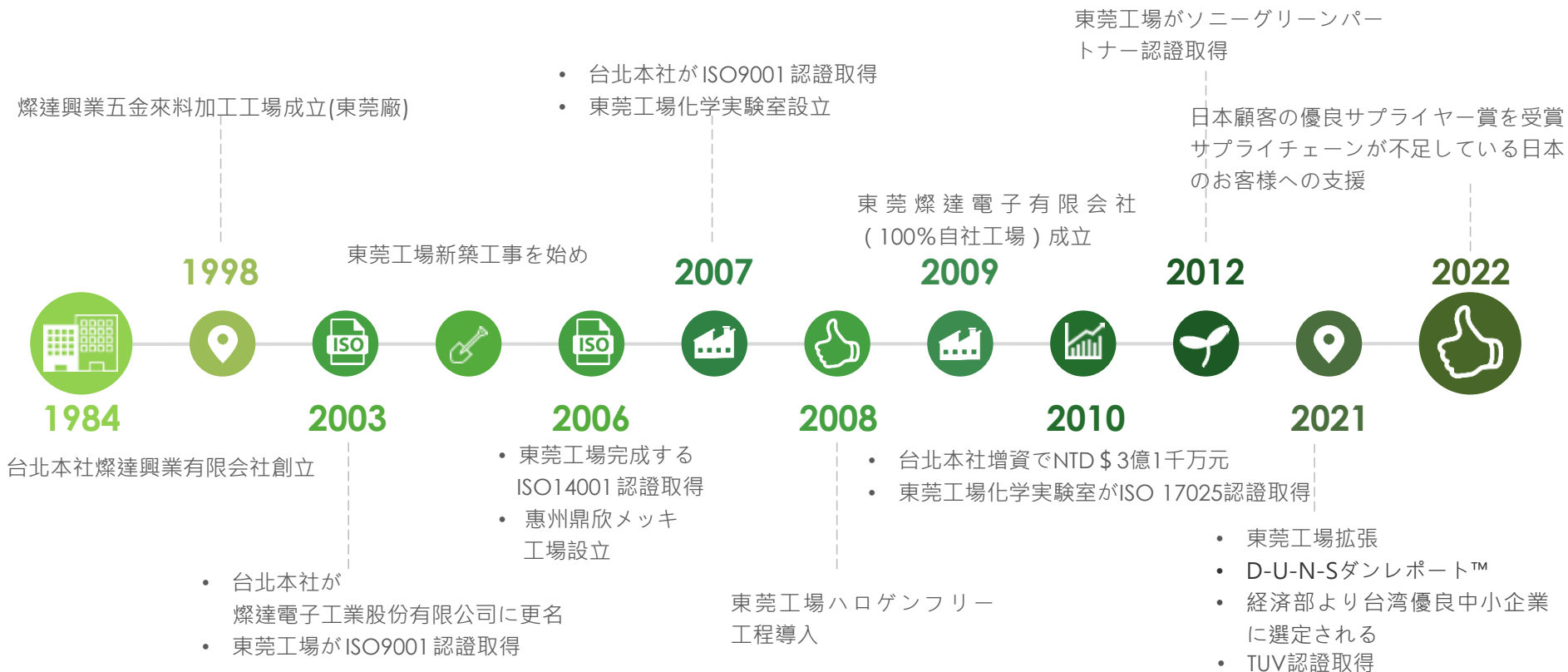

# 組成概況

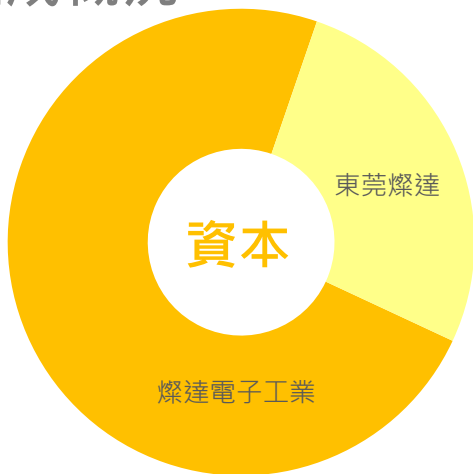

## 資本

燦達電子工業(股)公司

実収総資本金：

USD 10,000,000

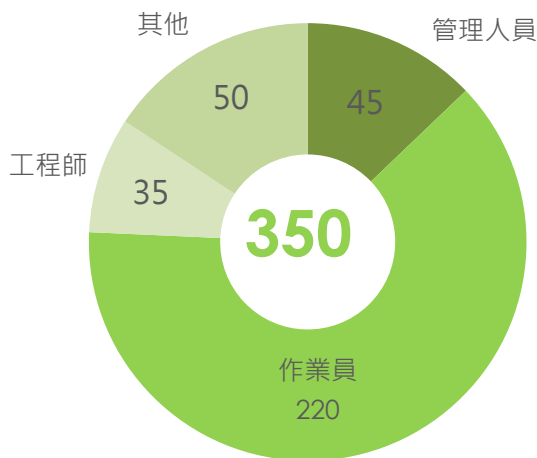

## 人員

管理者：45名

従業員：220名

エンジニア：35名

他に：50名

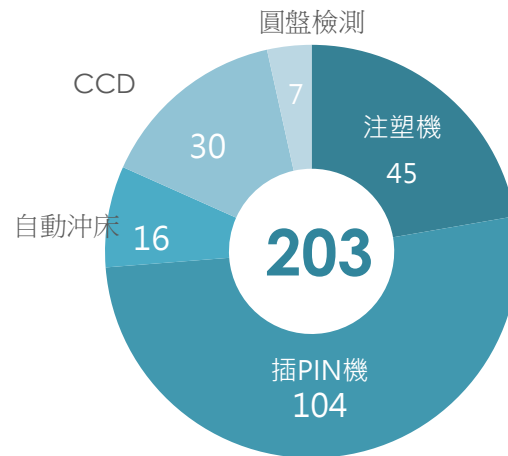

## 工場敷地12,500 square meter 設備

射出成形機：45 sets

插PIN機：104 sets

スタンピング：16 sets

CCD自動検査機：30 sets

ディスク検査機: 7 sets

車載専用組立自動機：1 set



# 製品開発

---

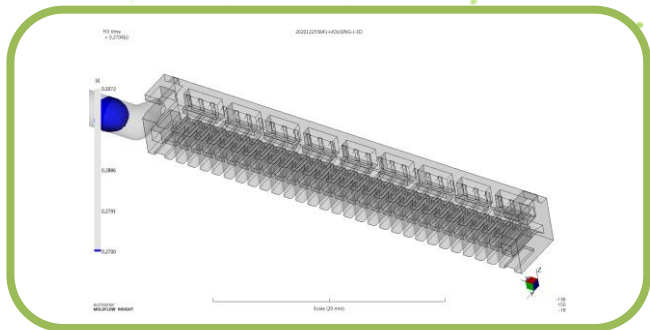



- OEM/ODM
- シミュレーション
- 2D 設計 (Auto CAD)
- 3D 設計 (Creo/Pro-E)
- スタンプング及び射出成型
- 自動化

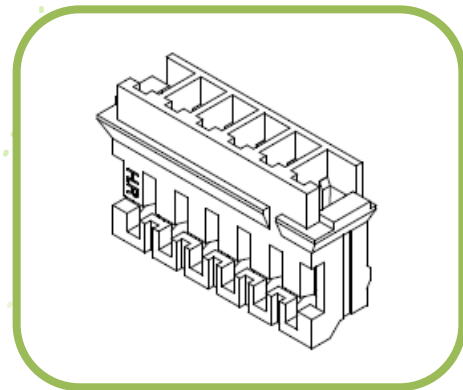
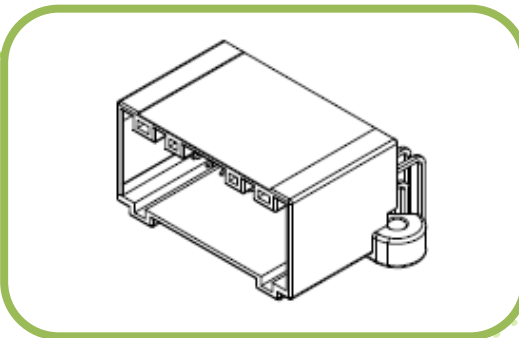
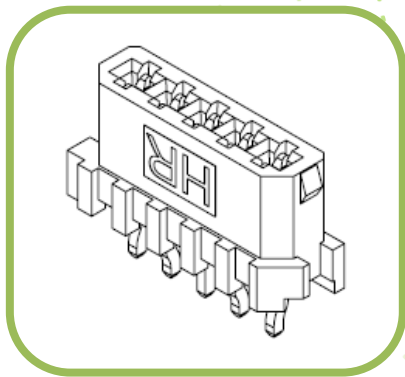
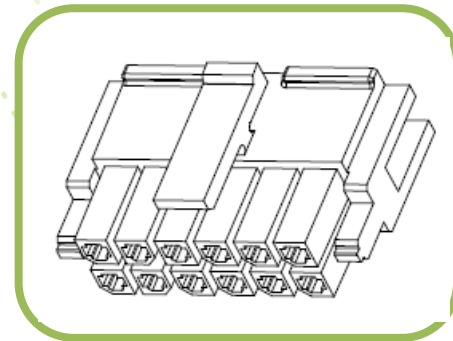
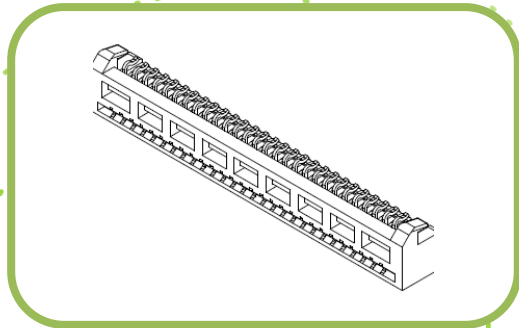
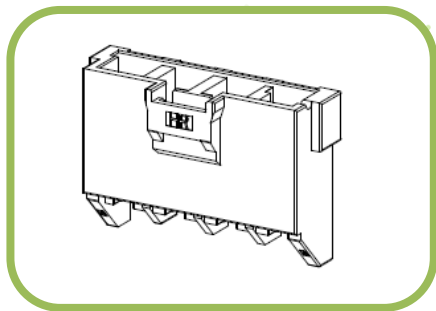

# 開発能力



# 原料仕入れ

		 			 		 
PBT UL94-V0	Nylon 66 UL94 – V2	Nylon 66 UL94 - V0	Nylon 66 UL94 - V0	Nylon 46 UL94-V0	Nylon 6T UL94-V0	LCP UL94-V0	Phosphor bronze/Brass

## 国際認証



# 開発の流れ



01

企画會議

Project Meeting

02

開發 / 設計

R & D

03

金型の設計

Mold Design

04

端子沖圧 / メッキ  
プラスチック射出

Metal Compression  
/ Electroplating  
/ Plastic Injection

05

成品 / ワイヤー  
組立

Product Assembly  
& Cable Assembly

06

試作検証

Test Run



液晶テレビ/パネル  
LCD & CRT TV & Monitor



ノートパソコン  
Notebook Computer



電子部品  
Computer & Components



家庭電器  
Electrical Appliances

自動車

Automobile



通信

Communication Products



OA 設備

OA Equipment



工業用

Industry Equipment







# 生產能力



放電加工



フライス盤



グラインダー

# スタンピング











CCDカメラ：品質検測

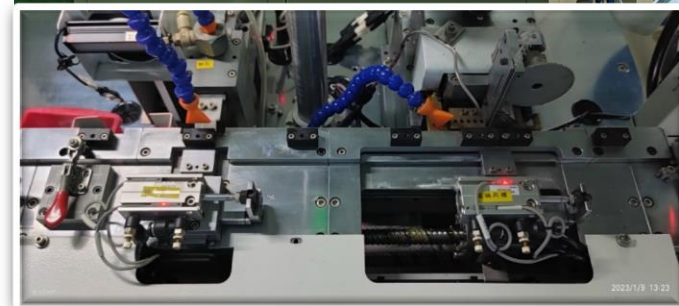
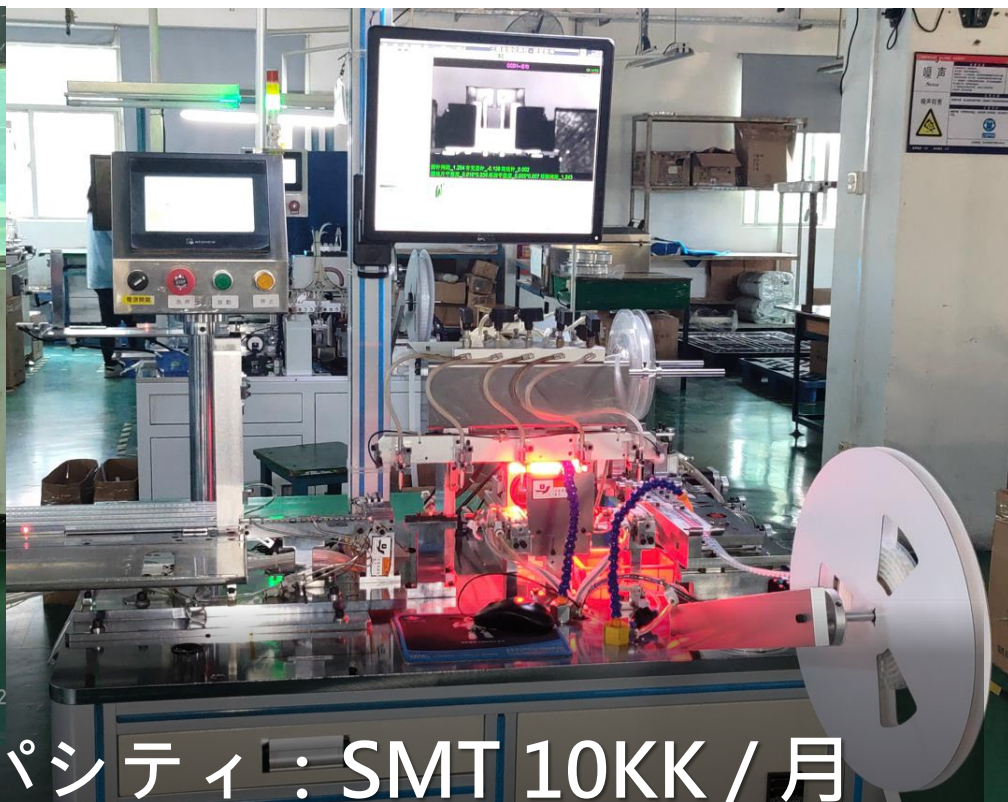

2022  
キャパシティ：SMT 10KK / 月



# 組立生産ライン

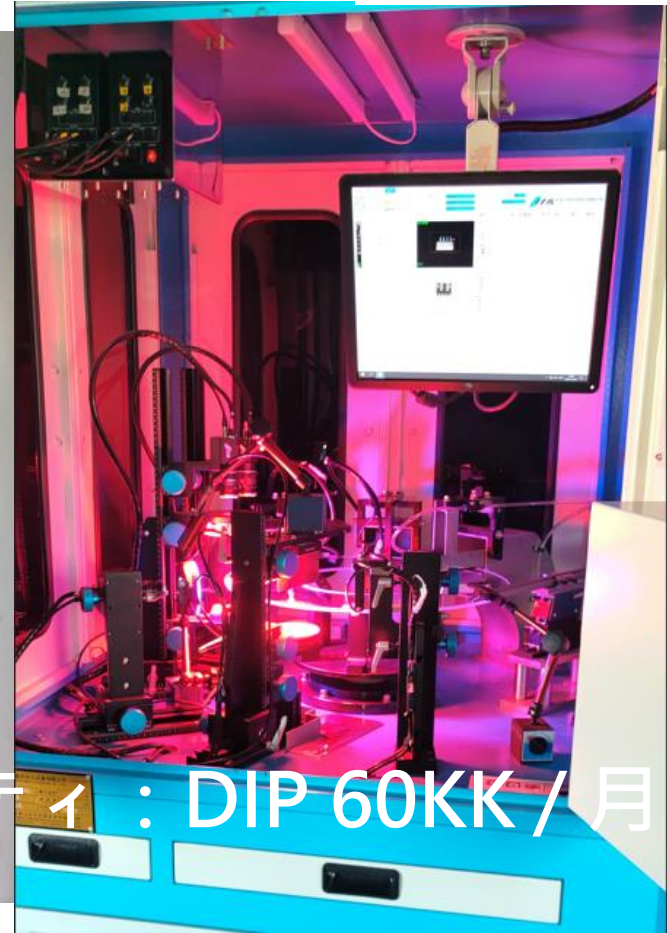
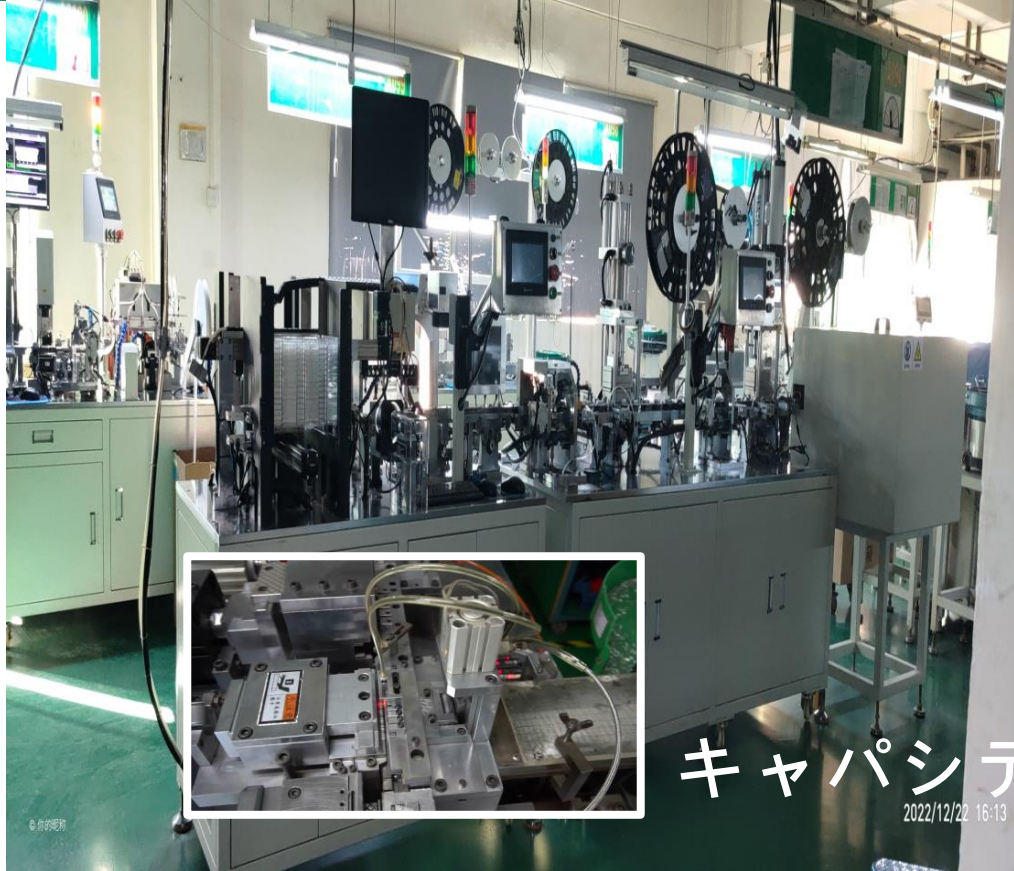

キャパシティ : DIP 60KK / 月

# ディスク検査機

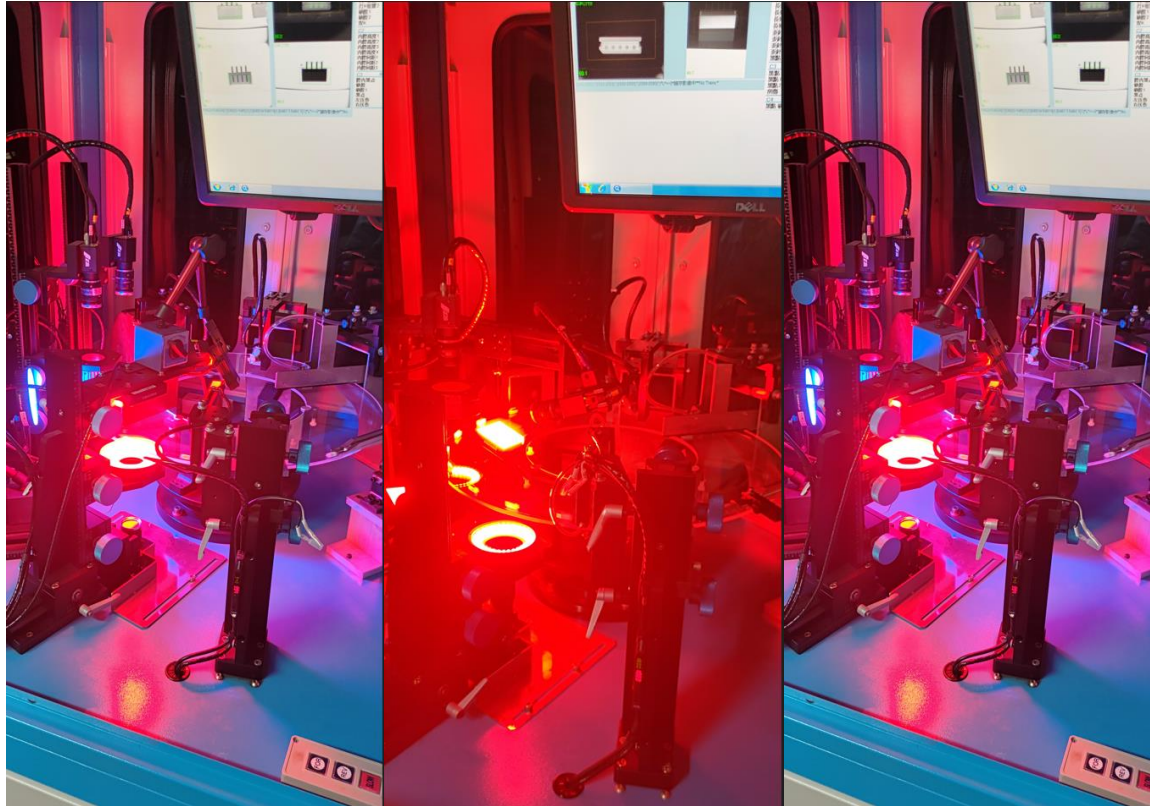



# 車載專用組立自動機



A blurred background image of a business meeting. In the foreground, a person in a blue suit is holding a silver pen over a white tablet held by another person. The scene is brightly lit, suggesting an office environment.

# 品質への 取り組み

---



剝離測定機



恒温恒濕試験機



温度試験機

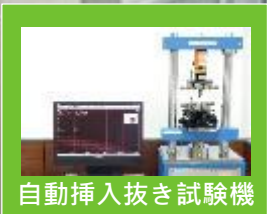

自動挿入抜き試験機



半田試験機



塩水鹽霧測試機



冷熱衝擊試験機



絶縁耐電圧試験機



マイクロ抵抗計

# グローワイヤーテスト

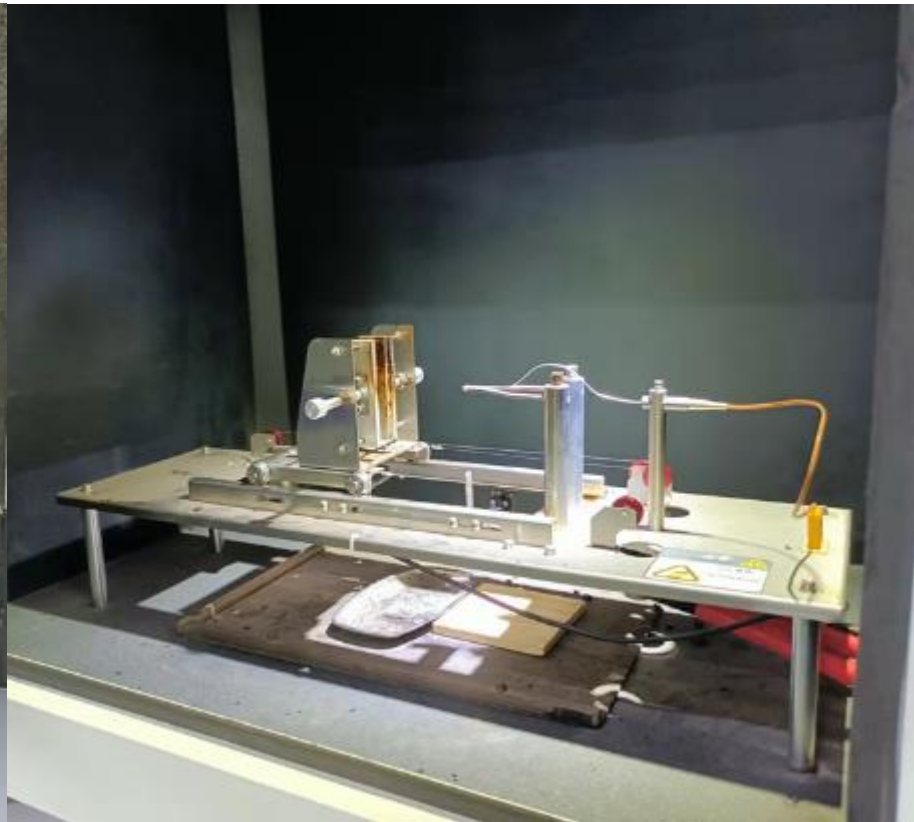



# X射線螢光分光計



**Joint Tech**  
Join your life, design, future





# 業績情報

販売先



**Joint Tech**  
Join your life, design, future



B/S/H/



**TOSHIBA**





# 年間売上金額



## 地域別売上金額比率

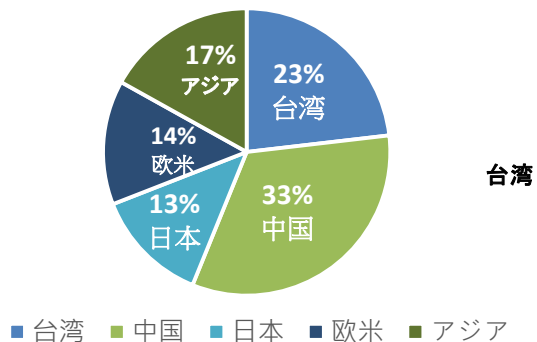

## 応用種別売上金額比率

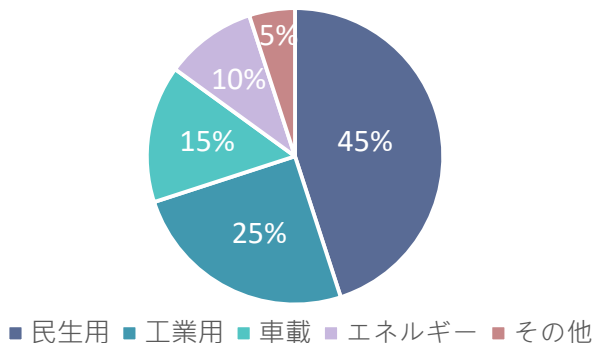

## USD (million)

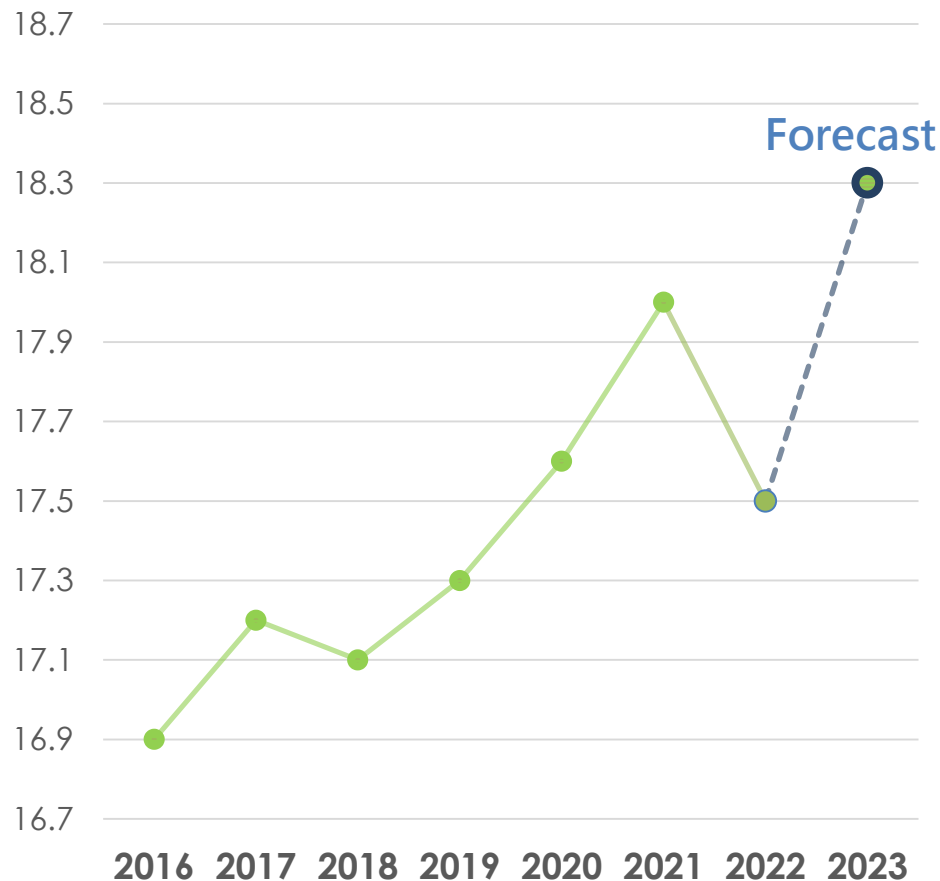



## 台湾本社

新北市汐止區大安街48號4樓

TEL : 886-2-86480379

FAX : 886-2-86478373

● 營業拠点 ● 海外得意先



# Thank you

Phone : 886-2-86480379

E-mail : [info@hr-connector.com.tw](mailto:info@hr-connector.com.tw)

地址 : 22178 新北市汐止區大安街48號4樓

[www.hr-connector.com.tw](http://www.hr-connector.com.tw)